

Turb 430 IR

Turb 430 T

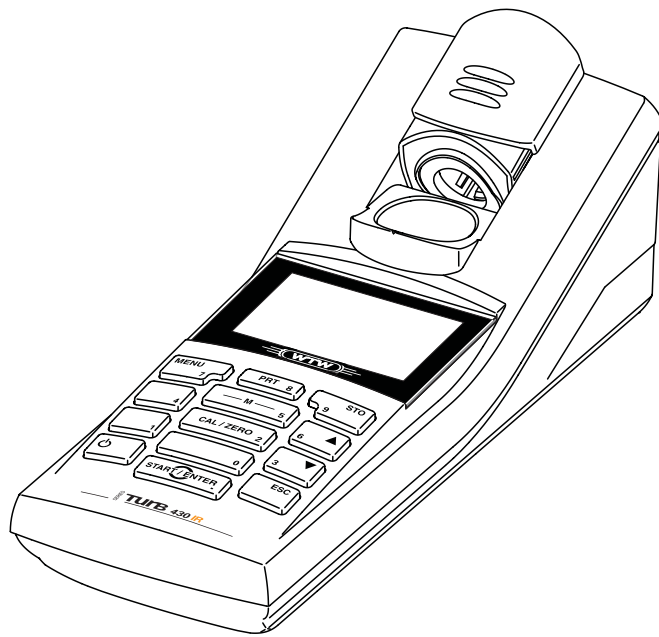

Handheld Turbidimeter

**Accuracy when
going to press**

The use of advanced technology and the high quality standard of our instruments are the result of continuous development. This may result in differences between this operating manual and your instrument. Also, we cannot guarantee that there are absolutely no errors in this manual. Therefore, we are sure you will understand that we cannot accept any legal claims resulting from the data, figures or descriptions.

**Firmware
Operating manual**

Part of the process of consequently improving our products is the continuous further development of instrument firmware. All current data for the Turb 430 IR/T can be found on the Internet under <http://www.WTW.com>:

- Firmware
- Operating manual

You can easily transfer new firmware to your instrument with the aid of the AK 540/B cable and a PC. More detailed information can be found in the appendix of the detailed operating manual on the CD-ROM provided.

Copyright

© 2005, WTW GmbH
Reprinting - even as excerpts - is only allowed with the explicit written authorization of WTW GmbH, Weilheim.
Printed in Germany.

1	Overview	5
1.1	General features	5
1.2	Keypad	6
1.3	Display	7
1.4	Socket field	7
1.5	LabStation (optional)	8
2	Safety	9
2.1	Authorized use	10
2.2	General safety instructions	10
3	Commissioning	13
3.1	Scope of delivery	13
3.2	Power supply	13
3.3	Connecting the LabStation	15
3.4	Initial commissioning	17
4	Operation	19
4.1	Switching on the meter	19
4.2	Inserting a cell	20
4.3	General operating principles	21
4.3.1	Operating modes	21
4.3.2	Navigation	21
4.3.3	Navigation example 1: setting the language	24
4.3.4	Navigation example 2: setting the date and time	25
4.3.5	Menu overview	26
4.4	System settings (<i>System</i> menu)	28
4.4.1	<i>Measured value memory</i>	29
4.4.2	<i>Display</i>	31
4.4.3	<i>Interface</i>	31
4.4.4	<i>Date/time</i>	32
4.5	Turbidity	33
4.5.1	General information	33
4.5.2	Aligning and marking a cell	33
4.5.3	Measuring turbidity	34
4.5.4	Settings for turbidity measurements	36
4.5.5	Calibration	36
4.6	Saving	40
4.6.1	Storing measurement datasets	40
4.6.2	Filtering measurement datasets	41
4.6.3	Displaying measurement datasets	42
4.6.4	Download the measurement datasets to the RS232 interface	42
4.6.5	Erasing stored measurement datasets	43
4.7	Transmitting data (RS 232 interface)	43
4.7.1	Connecting a PC/external printer	44

4.7.2	Configuring the RS232 interface	44
4.7.3	Selecting the output format of datasets	45
4.7.4	Transmitting data	47
4.8	Reset	48
4.8.1	Resetting the system settings	48
4.8.2	Resetting turbidimeter settings	48
4.9	Meter information	49
4.10	Software update	49
5	Maintenance, cleaning, disposal	51
5.1	Maintenance	51
5.1.1	Inserting/exchanging the batteries	51
5.1.2	Retrofitting the accumulator pack	52
5.2	Cleaning	53
5.2.1	Cleaning the cell shaft	53
5.2.2	Cleaning the cells	53
5.3	Disposal	54
6	What to do if...	55
6.1	General errors	55
6.2	Turbidity	55
7	Technical data	57
7.1	General data	57
7.1.1	Turb 430 IR/T	57
7.1.2	LabStation	58
7.2	Turbidity	59
7.2.1	Turb 430 IR	59
7.2.2	Turb 430 T	59
8	Accessories, options	61
8.1	WTW accessories	61
8.1.1	Connection cable:	61
9	Lists	63
10	Index	67
	Appendix: Firmware update	69
	Appendix: Turbidity values under 1 FNU/NTU	70

1 Overview

1.1 General features

The compact Turb 430 IR/T handheld precision turbidimeter enables you to carry out turbidity measurements quickly and reliably.

The Turb 430 IR/T handheld meter provides the maximum degree of operating comfort, reliability and measuring certainty for all applications.

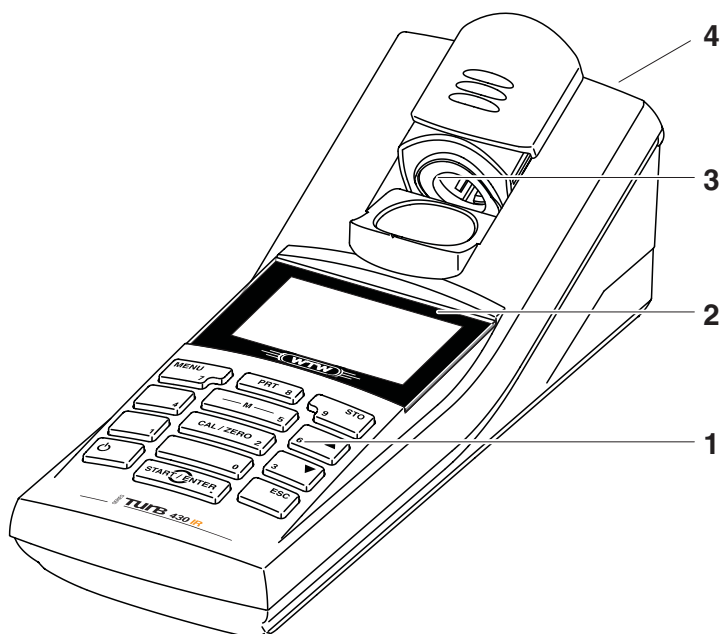

1	Keypad
2	Display
3	Cell shaft
4	Socket field



Note

If you need further information or application notes, you can obtain the following material from WTW:







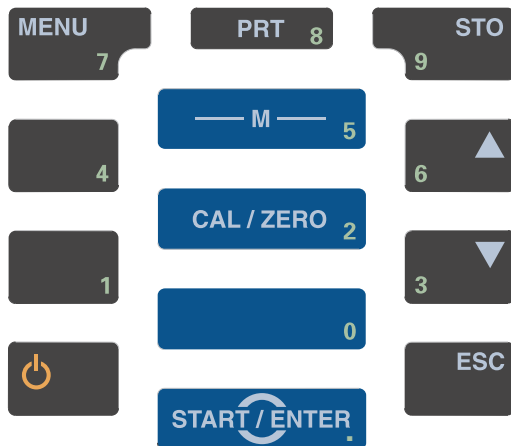

- Application reports
- Primers
- Safety datasheets.

Information on available literature is given in the WTW catalog or on the Internet under www.WTW.com.

1.2 Keypad



Key functions

	Switch to the measured value display <M>
	Start calibration <CAL/ZERO>
	Open menus / confirm entries / start measurement <START/ENTER>
	Call up the <i>Configuration</i> menu (all settings are made here) <MENU>
	Switch the measuring instrument on/off <ON/OFF>
	Output display contents to RS232 interface (e.g. print) <PRT>
	Open the <i>Store</i> menu: <STO> Quick storing: 2 x <STO>
	Highlight menu items or selection Set values <▲>, <▼>
	Switch to the next higher menu level / cancel input <ESC>



Note

Keys with an additional number printed on are assigned doubly. This enables to directly enter numbers in special menus. Thus, you can, for example, conveniently enter the date and time via the number keys.

1.3 Display

The graphic display shows all information of the current measurement in the measured value display. The illumination enables to read the display even in the darkness.

Example

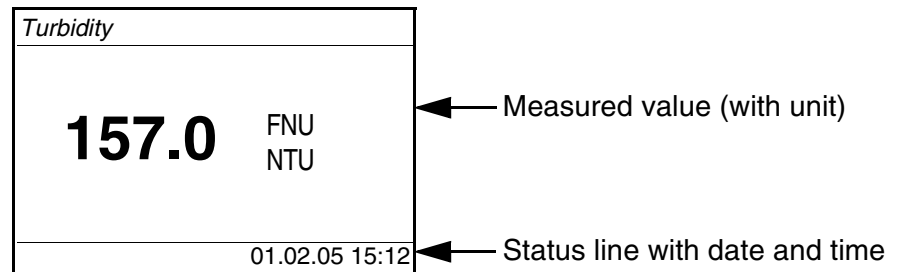

1.4 Socket field

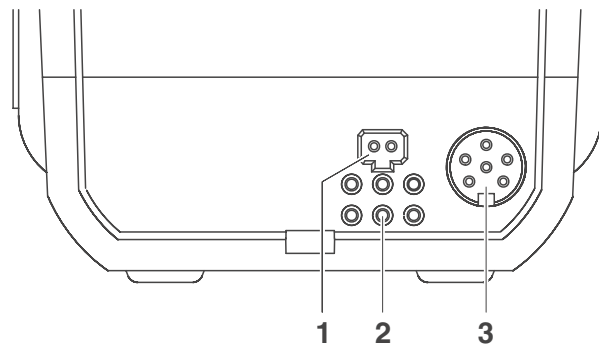

Identifying the connectors

1	Power pack
2	Contacts for operation on the LabStation
3	RS232 serial interface

1.5 LabStation (optional)

With the LabStation, which is available as an accessory, you can conveniently use the Turb 430 IR/T in the laboratory.

Laboratory operation with the LabStation enables the following additional functions:

- Line power operation is possible to save the batteries or accumulator pack
- The accumulator pack in the Turb 430 IR/T is automatically charged as soon as the meter is placed in the LabStation.

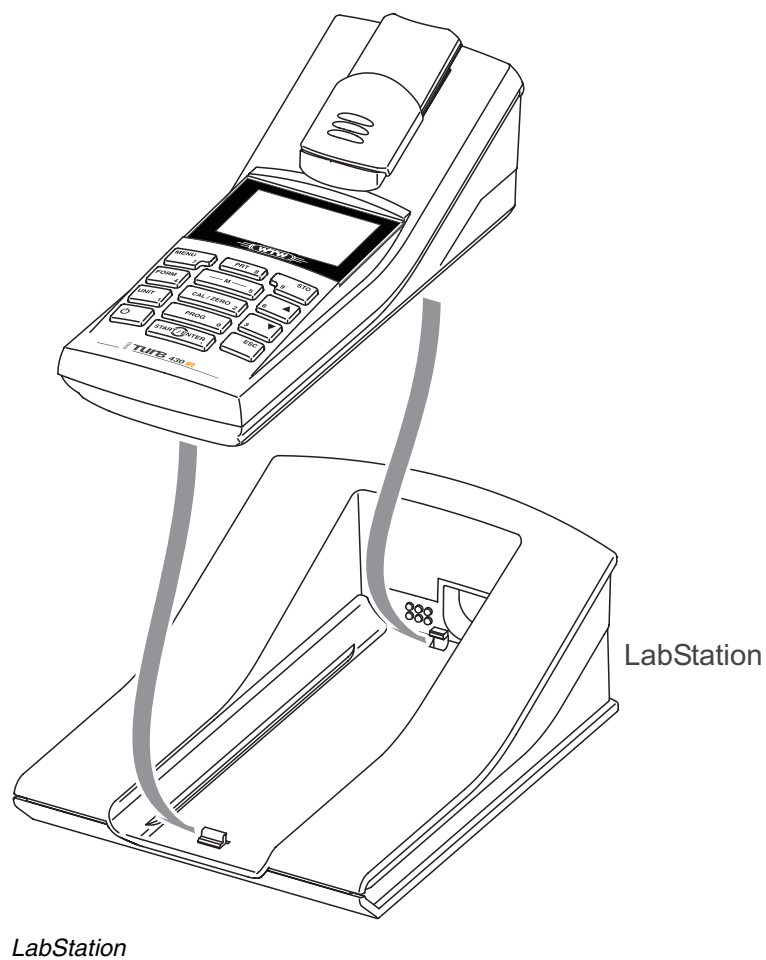

2 Safety

This operating manual contains basic instructions that you must follow during the commissioning, operation and maintenance of the meter. Consequently, all responsible personnel must read this operating manual carefully before working with the meter. The operating manual must always be available within the vicinity of the meter.

Target group

The meter was developed for work in the field and in the laboratory. Thus, we assume that, as a result of their professional training and experience, the operators will know the necessary safety precautions to take when handling chemicals.

The personnel responsible for the commissioning, operation and maintenance must have the necessary qualifications for this work. If the personnel do not have the required skills they have to be instructed. Furthermore, it must be ensured that the personnel read and completely understand the present operating manual.

Safety instructions

Safety instructions in this operating manual are indicated by the warning symbol (triangle) in the left column. The signal word (e.g. "Caution") indicates the level of danger:



Caution

indicates instructions that must be followed precisely in order to avoid the possibility of slight injuries or damage to the instrument or the environment.

Further notes



Note

indicates notes that draw your attention to special features.

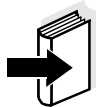

Note

indicates cross-references to other documents, e.g. operating manuals.

2.1 Authorized use

This meter is authorized exclusively for carrying out turbidity measurements in the field and laboratory.

The technical specifications as given in chapter 7 TECHNICAL DATA must be observed. Only the operation and running of the meter according to the instructions given in this operating manual is authorized. Any other use is considered to be **unauthorized**.

2.2 General safety instructions

This instrument is built and inspected according to the relevant guidelines and norms for electronic measuring instruments (see chapter 7 TECHNICAL DATA).

It left the factory in a safe and secure technical condition.

Opening the photometer or adjustment, maintenance and repair work must only be performed by specialist personnel authorized by the manufacturer.

The only exceptions to this are the activities described in chapter 5 MAINTENANCE, CLEANING, DISPOSAL. Non-compliance results in the loss of warranty claims.

Follow the points listed below when operating the photometer:

- Follow the local safety and accident prevention regulations
- Observe the enclosed instructions of reagents and accessories
- Observe the regulations when dealing with dangerous substances
- Follow the operating instructions at the workplace
- Use only original spare parts.

Function and operational safety

The smooth functioning and operational safety of the meter can only be guaranteed if the generally applicable safety measures and the specific safety instructions in this operating manual are followed during operation.

The smooth functioning and operational safety of the meter can only be guaranteed under the environmental conditions that are specified in chapter 7 TECHNICAL DATA.

If the instrument was transported from a cold environment to a warm environment, the formation of condensate can lead to the faulty functioning of the instrument. In this event, wait until the temperature of the instrument reaches room temperature before putting the instrument back into operation.

Safe operation

It is the responsibility of the operator to continuously observe the overall technical condition (externally recognizable deficits and damage as well as alterations to the operational behavior) of the meter.

If safe operation is no longer possible, the instrument must be taken out of service and secured against inadvertent operation!

Safe operation is no longer possible if the meter:

- has been damaged in transport
- has been stored under adverse conditions for a lengthy period of time
- is visibly damaged
- no longer operates as described in this manual.

If you are in any doubt, please contact the supplier of the instrument.

**Caution**

Danger of eye damage by visible and invisible LED radiation. In the cell shaft of the Turb 430 IR there are light emitting diodes (LED) of the 1M class. Do not look at the radiation using optical instruments. With normal, authorized use there is no hazard.

Obligations of the purchaser

The purchaser of this meter must ensure that the following laws and guidelines are observed when using dangerous substances:

- EEC directives for protective labor legislation
- National protective labor legislation
- Safety regulations
- Safety datasheets of the chemical manufacturers.

3 Commissioning

3.1 Scope of delivery

- Handheld turbidimeter Turb 430 IR or Turb 430 T
- 4 batteries, 1.5 V type AA (in the battery compartment)
- Optional: Accumulator pack and power pack with Euro plug and exchange plugs for USA, UK, and Australia
- Optional: LabStation
- 5 empty cells 28 mm with label to mark the cell
- AMCO[®]-Clear turbidity standard
- Microfiber cloth to clean the meter
- Compact operating manual and short operating manual
- CD-ROM with detailed operating manual



Note

The optional parts of the scope of delivery are available as accessories (see section 8.1).

3.2 Power supply

You can operate the meter either with batteries, accumulator pack or a power pack. The power pack supplies the meter with low voltage (9 V DC). At the same time, the accumulator pack is charged. The accumulator pack is charged even while the meter is switched off.

The *LoBat* display indicator appears when the batteries or accumulator pack are nearly discharged.

approx. 36 hours.

Charging time of the accumulator pack



Caution

The line voltage at the operating site must lie within the input voltage range of the original power pack (SEE chapter 7 TECHNICAL DATA).



Caution

Use original power packs only (see chapter 7 TECHNICAL DATA).

**Note**

The accumulator pack should not be completely discharged. If you do not operate the instrument for a longer period of time you should charge the accumulator pack every six months.

Automatic switchoff function

The meter has an automatic switch-off function in order to save the batteries or accumulator pack (see section 4.4).

Display illumination

During operation with the batteries or accumulator pack the meter automatically switches off the display illumination if no key is pressed for 30 seconds. The illumination is switched on with the next keystroke again. The display illumination can also be switched off completely (see section 4.4.2).

**Note**

Power pack and accumulator pack are available as an accessory (see section 8.1).

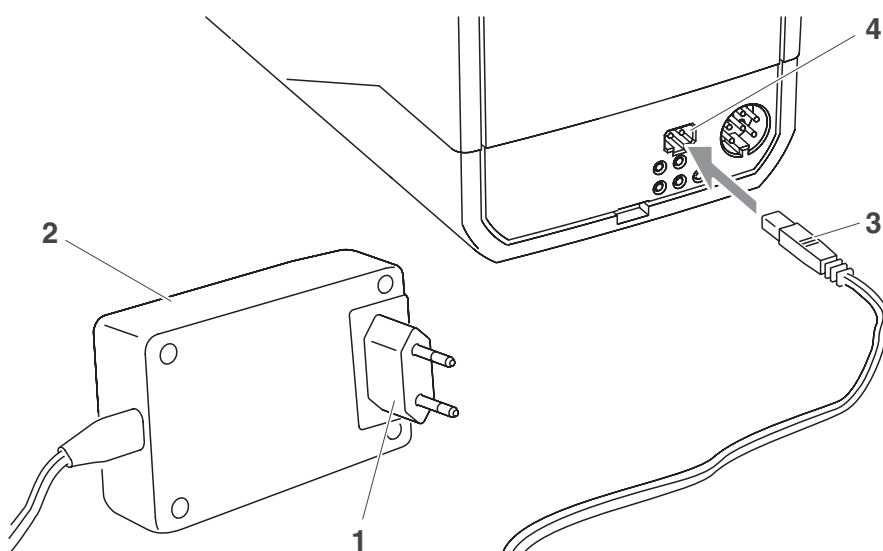
Connecting the power pack (optional)

- | | |
|---|---|
| 1 | If necessary, replace the Euro plug (1) on the power pack (2) by the country-specific plug suitable for your country. |
| 2 | Connect the plug (3) to the socket (4) of the turbidimeter. |
| 3 | Connect the power pack to an easily accessible power socket. |

3.3 Connecting the LabStation



Note

The LabStation is available as an accessory (see section 8.1).

In order to use the functions of the LabStation for operation in the laboratory, connect the LabStation and place the Turb 430 IR/T in the LabStation.

Connecting the LabStation (optional)

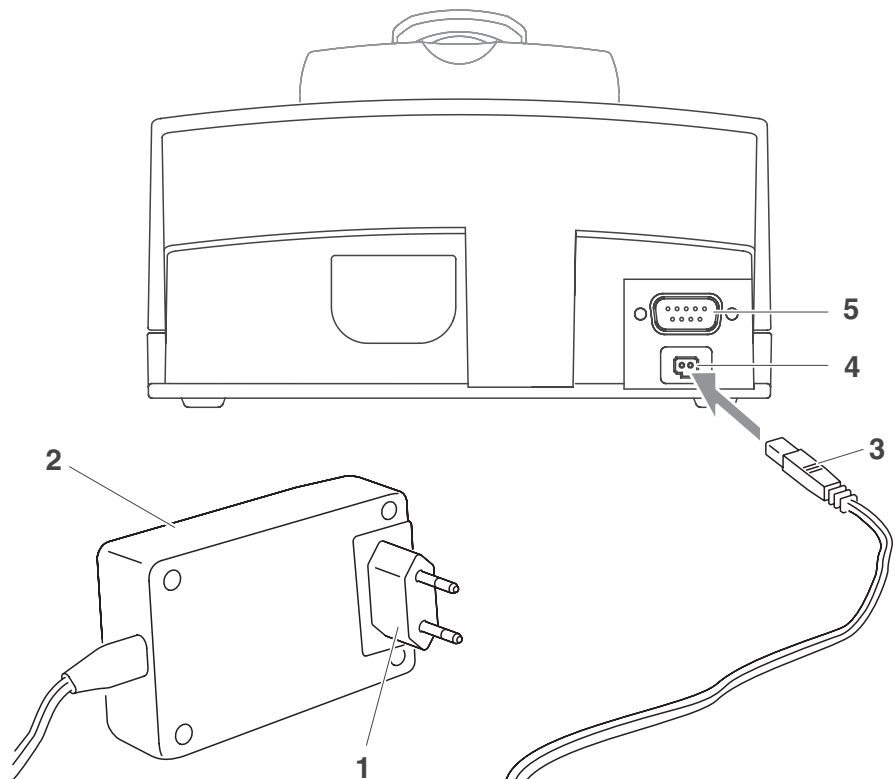

1	If necessary, replace the Euro plug (1) on the power pack (2) by the country-specific plug suitable for your country.
2	Connect the plug (3) to the socket (4) of the LabStation.
3	Connect a PC or printer to the socket (5) of the LabStation as necessary.
4	Connect the power pack to an easily accessible power socket.
5	Place the Turb 430 IR/T in the LabStation.

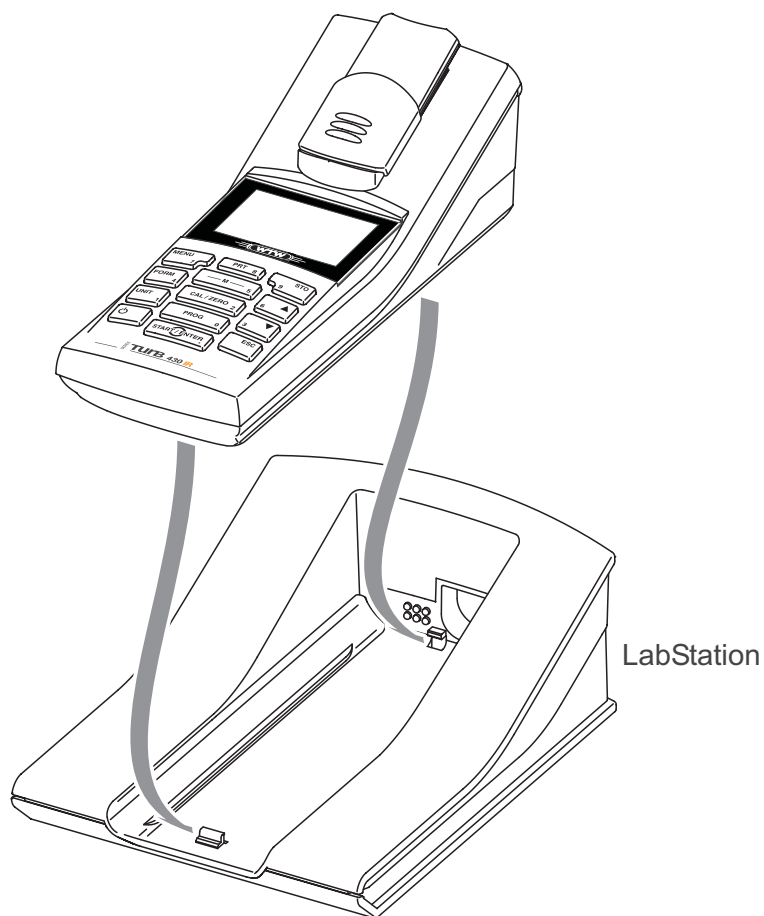

3.4 Initial commissioning

Perform the following activities:

- For
 - accumulator operation: insert the accumulator pack (see section 5.1.2)
 - line power operation and charging the accumulator pack: connect the power pack (see section 3.2)
 - operation with LabStation: connect the LabStation and place the Turb 430 IR/T in the LabStation (see section 3.3)
- Switch on the meter (see section 4.1)
- Set the language as necessary (see section 4.3.3)
- Set the date and time as necessary (see section 4.3.4)



Note

When you set the language, date and time according to the mentioned sections of this operating manual you will quickly become familiar with the simple operation of the Turb 430 IR/T.

4 Operation

4.1 Switching on the meter

Switching on

Press the **<ON/OFF>** key.

The *Start* menu appears for 30 seconds.

The status line indicates the meter designation and the version number of the software.

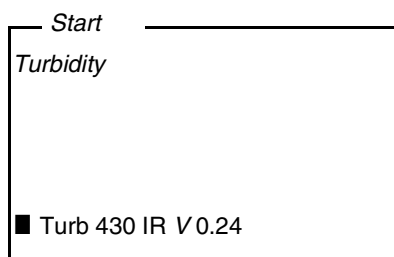

Note

in das Menü *Start* gelangen Sie bei eingeschaltetem Gerät durch ggf. mehrfaches Drücken der Taste **<ESC>**.

After a few seconds the meter automatically switches to the measuring mode.

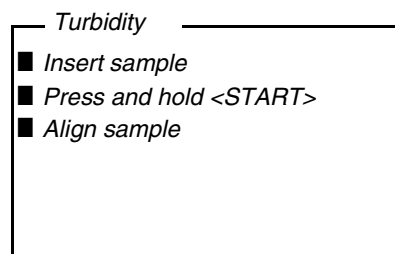

Switching off

Press the **<ON/OFF>** key.

Automatic switchoff function

The meter has an automatic switch-off function in order to save the batteries or accumulator pack (see section 4.4). The automatic switchoff switches off the meter if no key is pressed for an adjustable period.

The automatic switchoff is not active

- if the power is supplied by the power pack (optional),
- if the power is supplied by the LabStation (optional),
- if the *Timer* function is running.

Display illumination with battery-powered operation

During operation with batteries or accumulator pack the meter automatically switches off the display illumination if no key is pressed for 30 seconds. The illumination is switched on again with the next keystroke.

4.2 Inserting a cell

To be able to insert cells in the Turb 430 IR/T, the cell shaft has to be prepared to take in a cell.

- 1 Push the dust cover (1) upward.
The cell shaft for 28 mm cells is open.

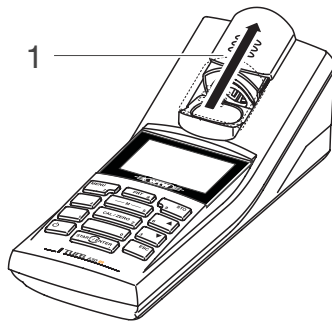

Inserting a 28 mm cell

- 2 Insert the cell so that it is positioned on the bottom of the cell shaft.
The cell is ready to be measured.



- 3 Align the cell (see section 4.5.2).

4.3 General operating principles

This section contains basic information on the operation of the Turb 430 IR/T.

Operating elements, display

An overview of the operating elements and the display is given in section 1.2 and section 1.3.

Operating modes, navigation

An overview of the operating modes of the Turb 430 IR/T and the navigation through menus and functions can be found in section 4.3.1 and section 4.3.2.

4.3.1 Operating modes

The instrument has the following operating modes:

- Measurement
The display indicates measurement data in the measured value display
- Calibration
The display indicates a calibration procedure with calibration information
- Data transmission
The meter transmits measuring datasets or calibration records to the serial interface
- Configuration
The display indicates a menu with further menus, settings and functions

4.3.2 Navigation

Measured value display

In the measured value display, open the menu with **<MENU>**.

Menus and dialogs

The menus for settings and dialogs in courses contain further submenus. The selection is made with the **<▲>** **<▼>** keys. The current selection is displayed in reverse video.

- Menus
The name of the menu is displayed at the upper edge of the frame. Menus are opened by confirming with **<START/ENTER>**. Example:

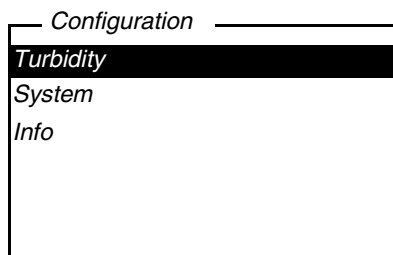

- **Settings**

Settings are indicated by a colon. The current setting is displayed on the right-hand side. With <START/ENTER>, the selection of the possible settings is opened. Subsequently, the setting can be changed with <▲> <▼> and <START/ENTER>.

Example:

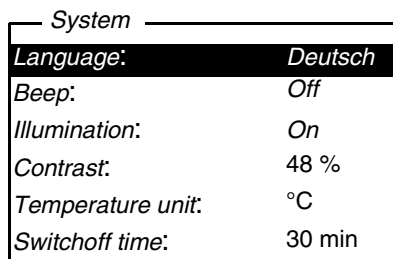

- **Functions**

Functions are designated by the name of the function. They are immediately carried out by confirming with <START/ENTER>.

Example: display the *Calibration record* function (in the *Turbidity* menu).

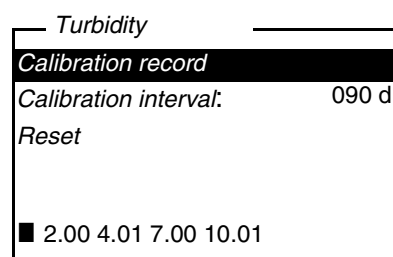

- **Messages**

Information or operating instructions are designated by the ■ symbol. They cannot be selected.

Example:

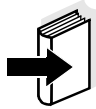
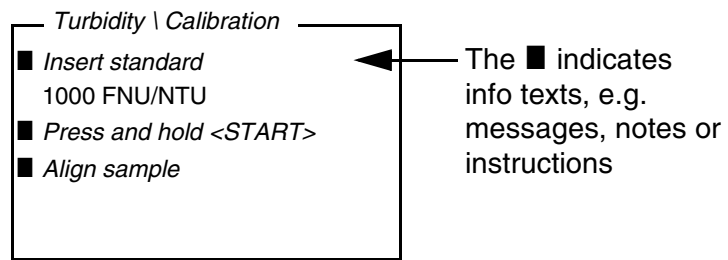
**Note**

The principles of navigation are explained in the two following sections by reference of examples:

- Setting the language (section 4.3.3)
- Setting the date and time (section 4.3.4).

4.3.3 Navigation example 1: setting the language



Note

The following example describes in the language of the country how to set the language. On delivery, English is set as the language in the Turb 430 IR/T. During initial commissioning, the language is set in the menu, *Configuration / System / Language*.

- | | |
|---|---|
| 1 | In the measured value display:
Open the <i>Configuration</i> menu with <MENU> .
The instrument is in the configuration mode. |
| 2 | Select the <i>System</i> menu with <▲> <▼> .
The current selection is displayed in reverse video. |
| 3 | Open the <i>System</i> menu with <START/ENTER> . |
| 4 | Select the <i>Language</i> menu with <▲> <▼> .
The current selection is displayed in reverse video. |

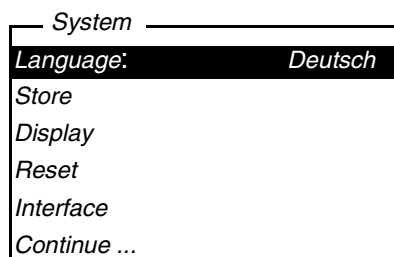

- | | |
|---|---|
| 5 | Open the setting of the <i>Language</i> with <START/ENTER> . |
|---|---|

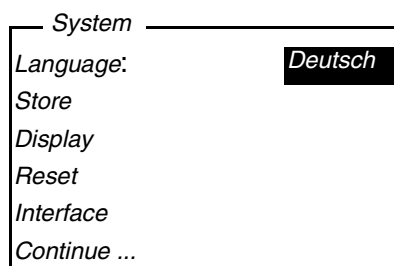

- | | |
|---|---|
| 6 | Select the required language with <▲> <▼> . |
| 7 | Confirm the setting with <START/ENTER> .
The setting is active. The menu is displayed in the selected language. |

- | | |
|---|--|
| 8 | To make further settings, switch to the next higher menu level with <ESC> . |
|---|--|

4.3.4 Navigation example 2: setting the date and time

The meter has a clock with a date function. The date and time are indicated in the status line of the measured value display. When storing measured values and calibrating, the current date and time are automatically stored as well.

Numerals are generally entered via the number keys.

The correct setting of the date and time and date format is important for the following functions and displays:

- Current date and time
- Calibration date
- Identification of stored measured values.

Therefore, check the time at regular intervals.



Note

After a fall of the supply voltage (empty batteries or accumulator pack), the date and time are reset to 01.01.2003, 00:00 hours.

Setting the date, time and date format

The data format can be switched from the display of day, month, year (*dd.mm.yy*) to the display of month, day, year (*mm/dd/yy* or *mm.dd.yy*).

- | | |
|---|---|
| 1 | In the measured value display:
Open the <i>Configuration</i> menu with <MENU> .
The instrument is in the configuration mode. |
| 2 | Select and confirm the <i>System / Continue ... / Date/time</i> menu with <▲> <▼> and <START/ENTER> . |

<i>Date/time</i>	
<i>Time:</i>	14:53:40
<i>Date:</i>	30.10.03
<i>Date format:</i>	<i>dd.mm.yy</i>

- 3 Select and confirm the *Time* menu with <▲> <▼> and <START/ENTER>. A display for the entry of numerals with the number keys opens up.

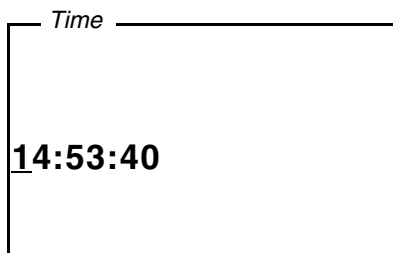

- 4 Enter the time using the number keys. The digit to be changed is displayed underlined.



Note

In the case of wrong entries, you can cancel the procedure with <ESC>. After canceling with <ESC>, it is possible to enter all digits once again. The new digits are only taken over by confirming with <START/ENTER>.

- 5 Confirm the setting with <START/ENTER>. The time is set.
- 6 Set the current *Date* as necessary. The setting is made similarly to that of the time.
- 7 Change the date format as necessary.
- 8 To make further settings, switch to the next higher menu level with <ESC>. or Switch to the measured value display with <M> (short pressure). The instrument is in the measurement mode.

4.3.5 Menu overview

<i>Turbidity</i>	<i>Calibration record</i>
	<i>Calibration interval</i>
	<i>Reset</i>
<i>Timer</i>	

<i>System</i>	<i>Language</i>	<i>Deutsch</i> <i>English</i> <i>Français</i> <i>Español</i>		
	<i>Measured value memory</i>	<i>Display</i>		
		<i>RS232 download</i>		
		<i>Data filter</i>	<i>Filter ID</i> <i>Date</i>	
		<i>Delete</i>		
		■ 4 of 1000 occupied		
		■ Filter: No filter		
	<i>Display</i>	<i>Illumination</i>	<i>Auto off</i> <i>On</i> <i>Off</i>	
		<i>Contrast</i>	0 ... 100 %	
		<i>Brightness</i>	0 ... 100 %	
	<i>Reset</i>			
	<i>Interface</i>	<i>Baud rate</i>	1200, 2400, 4800, 9600, 19200	
		<i>Output format</i>	<i>ASCII</i> <i>CSV</i>	
	<i>Continue ... / Date/time</i>	<i>Time</i>	hh:mm:ss	
		<i>Date</i>		
<i>Date format</i>		<i>dd.mm.yy</i> <i>mm.dd.yy</i> <i>mm/dd/yy</i>		
<i>Continue ... / Switchoff time</i>	10, 20, 30, 40, 50 min, 1, 2, 3, 4, 5, 10, 15, 20, 24 h			
<i>Continue ... / Beep</i>	<i>On</i> <i>Off</i>			

Info

4.4 System settings (System menu)

The following instrument features and general functions can be found in the *Configuration / System* menu:

- Language selection (*Language*)
- Memory and database functions (*Store*)
- Display settings (*Display*)
- Restore basic settings (*Reset*)
- Configuration of the interface for PC/printer (*Interface*)
- Setting the date/time (*Date/time*)
- Setting the switch-off time (*Switchoff time*)
- Setting the keyboard sound (*Beep*)

Settings/functions

The settings are given in the menu, *Configuration / System*. Move to the *Configuration* menu with the <MENU> key.

Menu item	Setting	Description
<i>Language</i>	<i>Deutsch</i> <i>English</i> <i>Français</i> <i>Español</i>	Select the language (see section 4.3.3)
<i>Store</i>	<i>Display</i> <i>RS232</i> <i>download</i> <i>Data filter</i> <i>Delete</i>	Memory and database functions (see section 4.6.2)
<i>Display</i>	<i>Illumination</i> <i>Contrast</i> <i>Brightness</i>	Switch on/off the display illumination (see section 4.4.2)
<i>Reset</i>	-	Resets all system settings to default (see section 4.8.1)
<i>Interface</i>	<i>Baud rate</i> <i>Output format</i>	Baud rate of the data interface (see section 4.4.3)
<i>Continue ... /</i> <i>Date/time</i>	<i>Time</i> <i>Date</i> <i>Date format</i>	Settings of time and date (see section 4.3.4)

Menu item	Setting	Description
<i>Continue ... / Switchoff time</i>	10, 20, 30, 40, 50 min, 1, 2, 3, 4, 5, 10, 15, 20, 24 h	The automatic switchoff function switches the meter off if no entry is made for a specified period of time (<i>Switchoff time</i>). This saves the batteries or accumulator pack.
<i>Continue ... / Beep</i>	<i>On</i> <i>Off</i>	Switch on/off the beep on keystroke

4.4.1 Measured value memory

In the *Measured value memory* menu, you find functions to display and edit the stored measurement datasets:

- Display the measurement datasets on the screen (*Display*)
- Download the measurement datasets to the RS232 interface (*RS232 download*)
- Set up filter rules for the stored measurement datasets (*Data filter*)
- Erase all stored measurement datasets (*Delete*)
- Information on the number of occupied memory locations

The settings are given in the menu, *Configuration / System / Measured value memory*.

Move to the *Configuration* menu with the <MENU> key.

Settings/functions	Menu item	Setting/function	Description
	<i>Display</i>	-	<p>Displays in pages all measurement datasets that correspond to the filter settings.</p> <p>Further options:</p> <ul style="list-style-type: none"> ● Scroll through the datasets with <▲> <▼>. ● Output the displayed dataset to the interface with <PRT>. ● Quit the display with <ESC>.
	<i>RS232 download</i>	-	<p>Downloads to the interface all measurement datasets that correspond to the filter settings. The download is ordered according to the date and time.</p> <p>The process can take several minutes. To terminate the process prematurely, press <ESC>.</p>
	<i>Data filter</i>	see section 4.6.2.	Allows to set filter criteria in order to display and download datasets to the interface.
	<i>Delete</i>	-	<p>Erases the entire contents of the measuring data memory, independent of the filter settings.</p> <p>Note: All calibration data remains stored when performing this action.</p>

All details on the subjects of memory and stored data is given in section 4.6.2.

4.4.2 Display

In the *Configuration / System / Display* menu, you set the display features:

- Switching on/off the display illumination (*Illumination*)
- Display contrast (*Contrast*)

The settings are given in the menu, *Configuration / System / Display*. Move to the *Configuration* menu with the <MENU> key.

Settings	Menu item	Setting	Description
	<i>Illumination</i>	<i>Auto off</i>	The display illumination is automatically switched off if no key has been pressed for 30 seconds.
		<i>On</i> <i>Off</i>	Switches the display illumination on or off permanently
	<i>Contrast</i>	0 ... 100 %	Changes the display contrast
	<i>Brightness</i>	0 ... 100 %	Changes the display brightness

4.4.3 Interface

In the *Interface* menu, you set the features of the interface:

- Transmission speed (*Baud rate*)
- Output format (*Output format*)

The settings are given in the menu, *Configuration / System / Interface*. Move to the *Configuration* menu with the <MENU> key.

Settings	Menu item	Setting	Description
	<i>Baud rate</i>	1200, 2400, 4800, 9600, 19200	Baud rate of the data interface
	<i>Output format</i>	<i>ASCII</i> <i>CSV</i>	Output format for data transmission For details, see section 4.7

4.4.4 Date/time

In the *Configuration / System / Continue ... / Date/time* menu, you set the system clock:

- Current time (*Time*)
- Current date (*Date*)
- Format of the date display (*Date format*)

The settings are given in the menu, *Configuration / System / Continue ... / Date/time*.

Move to the *Configuration* menu with the <MENU> key.

Settings	Menu item	Setting	Description
	<i>Time</i>	hh:mm:ss	Enter the time with the number keys
	<i>Date</i>		Enter the date with the number keys
	<i>Date format</i>	<i>dd.mm.yy</i> <i>mm.dd.yy</i> <i>mm/dd/yy</i>	Settings of time and date.

4.5 Turbidity

4.5.1 General information

Venting the sample

Air bubbles in the sample affect the measuring result to a massive extent because they have a large scattering effect on the incident light. Larger air bubbles cause sudden changes in the measured values whereas smaller air bubbles are recorded by the instrument as turbidity. Therefore, avoid or remove air bubbles:

Avoiding or removing air bubbles

- During sampling, ensure all movement is kept to a minimum
- If necessary, vent the sample (ultrasonic baths, heating or adding a surface-active substance to reduce the surface tension)



Note

For turbidity values under 1 FNU/NTU, follow the instructions given in the appendix (see APPENDIX: TURBIDITY VALUES UNDER 1 FNU/NTU).

4.5.2 Aligning and marking a cell

Even perfectly clean quality cells exhibit tiny directional differences in their light transmittance. Therefore, if you want to achieve accurate and reproducible measurement results, it is necessary to always index the sample cells and cells for calibration standards in the same way (see section 2130 of "Standard Methods for the Examination of Water and Wastewater", 19th edition).

To do so, the optimum alignment of the cell is determined.

Aligning the cell

1	Clean the cell (see section 5.2.2).
2	Insert the cell (see section 4.2).
3	Align the cell: <ul style="list-style-type: none"> ● Press and hold the <START/ENTER> key. ● Slowly and in small steps rotate the cell by one complete rotation (by 360 °). After each step wait for a short time until the displayed measured value is stable. ● Turn the cell back to the position with the lowest measured value.



Note

To keep the drift as low as possible, the time for aligning the cell while pressing and holding the <START/ENTER> key is limited to 30 seconds. After this time, the meter starts measuring automatically.

- | | |
|---|--|
| 4 | Release the <START/ENTER> key.
Measurement starts. The measured value is displayed. |
|---|--|

Marking a cell

To be able to quickly bring a cell into the optimum position, it is helpful to mark the optimum position of the cell once it is determined. This shortens each measurement or calibration procedure with this cell considerably.

The marking can, e. g., be done on a label on the cap of the cell.

- | | |
|---|--|
| 5 | Mark the optimum position of the cell.
The cell is prepared for the shortened measuring and calibration procedures. |
|---|--|

4.5.3 Measuring turbidity



Caution

Never pour any liquids directly into the cell shaft. Always use a cell for measurement. The meter only measures precisely if the cell is closed with the black light protection cap (WTW cells).



Note

The outside of the cell always has to be clean, dry, and free of fingerprints and scratches. Clean the cells before starting to measure (see section 5.2.2). Only hold the cells by the top or by the black light protection cap.

Measuring

- | | |
|---|--|
| 1 | Rinse out a clean cell with the sample to be measured:
Pour approximately 10 ml sample into the cell. Close the cell and rotate it several times before throwing the sample away. |
| 2 | Repeat the rinsing procedure twice more. |
| 3 | Fill the cell with the sample to be measured (approx. 15 ml).
Close the cell with the black light protection cap. |
| 4 | Clean the cell (see section 5.2.2). |
| 5 | Insert the cell (see section 4.2). |

- 6 | Align the cell:
- Marked cell
 - Align the marking on the cell cap with the marking on the cell shaft.
 - Press and for a short time hold the **<START/ENTER>** key until the measured value is displayed.
 - Unmarked cell (see page 33)
 - Press and hold the **<START/ENTER>** key.
 - Slowly and in small steps rotate the cell by one complete rotation (by 360 °). After each step wait for a short time until the displayed measured value is stable.
 - Turn the cell back to the position with the lowest measured value.

**Note**

To keep the drift as low as possible, the time for aligning the cell while pressing and holding the **<START/ENTER>** key is limited to 30 seconds. After this time, the meter automatically starts measuring or calibrating.

- 7 | Release the **<START/ENTER>** key.
Measurement starts. The measured value is displayed.

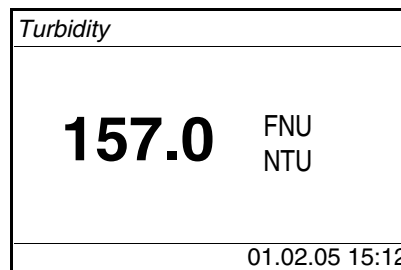

- 8 | Repeat the steps 2 to 8 for further samples.

**Display with measuring
range overflow**

If the measured value is outside the measuring range of the Turb 430 IR/T, it is indicated on the display:

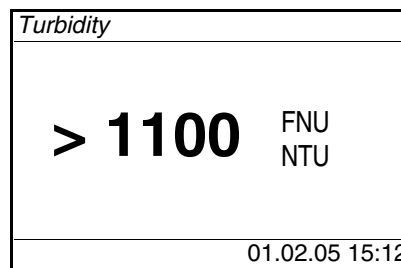

4.5.4 Settings for turbidity measurements

Overview

For turbidity measurements, the following settings are possible in the menu, *Configuration / Turbidity*:

- *Calibration record* (display, print)
- Entering the *Calibration interval*
- *Reset*

Settings/functions

The settings are given in the menu, *Configuration / Turbidity*. Move to the *Configuration* menu with the <MENU> key.

Menu item	Possible setting	Description
<i>Calibration record</i>	-	Displays the calibration record of the last calibration.
<i>Calibration interval</i>	1 ... 999 d	<i>Calibration interval</i> for turbidity measurement (in days). If the calibration interval has expired, the meter reminds you to calibrate before each measurement.
<i>Reset</i>		Reset all settings for the <i>Turbidity</i> measuring mode (see section 4.8.2)

4.5.5 Calibration

When to calibrate?

- After the calibration interval has expired
- With a temperature change

Calibration procedures and calibration standards

For the menu-guided three-point calibration you need the following three calibration standards in the mentioned order:

Standard no.	FNU/NTU
1	1000
2	10,0
3	0,02

Calibration record

At the end of each calibration procedure a calibration info (■ symbol) and the calibration record is displayed.

Displaying and downloading calibration data to interface

You can view the data of the last calibration on the display. Subsequently, you can download the displayed calibration data to the interface, e. g. to a printer or PC, with the <PRT> key.

The calibration record of the last calibration can be found under the menu item, *Configuration / Turbidity / Calibration record*.

Sample printout of a record

```
31.10.03 16:13
Turb 430 IR Ser. no. 12345678
Calibration Turbidity
Calibration date 31.10.03 16:13:33
Calibration interval 90 d
```

Preparing the calibration

Perform the following preparatory activities when you want to calibrate:

- | | |
|---|--|
| 1 | Keep the cells with the required calibration standards ready and mark them as necessary (see page 33). |
| 2 | Clean the cell (see section 5.2.2). |
| 3 | Insert the cell (see section 4.2). |

**Note**

For turbidity values under 1 FNU/NTU, follow the instructions given in the appendix (see APPENDIX: TURBIDITY VALUES UNDER 1 FNU/NTU).

Carrying out calibration

- | | |
|---|---|
| 1 | Press the <CAL/ZERO> key.
The menu-guided calibration begins.
Follow the instructions on the display. |
|---|---|

```
— Turbidity \ Calibration —
■ Insert standard
  1000 FNU/NTU
■ Press and hold <START>
■ Align sample
```

- | | |
|---|---|
| 2 | Insert the cell with the displayed calibration standard (here e.g. 1000 FNU/NTU) in the cell shaft (see section 4.2). |
|---|---|

- 3 Align the cell:
 - Marked cell:
 - Align the marking on the cell cap with the marking on the cell shaft.
 - Press and hold the **<START/ENTER>** key until the measured value is displayed.
 - Unmarked cell (see page 33)
 - Press and hold the **<START/ENTER>** key.
 - Slowly and in small steps turn the cell by one complete rotation (by 360 °).
 - After each step wait for a short time until the displayed measured value is stable.
 - Turn the cell back to the position with the lowest measured value.

Turbidity \ Calibration

- *Turb. = 1000 FNU/NTU*
- *Start calibration*
by releasing <START>

4 Release the **<START/ENTER>** key.
Measurement of the calibration standard begins.



Note

Before measuring the third calibration standard of 0.02 FNU/NTU you can exit the calibration with **<ESC>** at any time. The new calibration data is discarded. The old calibration data is further used.

5 Repeat the steps 4 - 6 with the calibration standards, 10.0 FNU/NTU and 0.02 FNU/NTU.
After measuring the 0.02 FNU/NTU calibration standard, the calibration result is displayed.
Calibration is completed.

6 Confirm the calibration result with **<START/ENTER>**.
The calibration record is displayed.

7 Confirm the calibration record with **<START/ENTER>**.
The display shows instructions for the first measurement.

Turbidity

- *Insert sample*
- *Press and hold <START>*
- *Align sample*

**Note**

If ■ *Calibration error!* was displayed as the calibration result, a note appears on the display to recalibrate before measuring. Should a valid calibration not be possible the meter also offers to continue measuring with the last valid calibration data.

4.6 Saving

The meter has 1000 memory locations for measurement datasets.

You can transmit measured values (datasets) to the data memory with the <STO> key.

Each storage process transmits the current dataset to the interface at the same time.

The number of memory locations that are still free is displayed in the *Store* menu. The number of memory locations that are occupied is displayed in the *System Measured value memory* menu.

Measurement dataset

A complete dataset consists of:

- Date/time
- ID number (ID)
- Measured value

4.6.1 Storing measurement datasets

Proceed as follows to transmit to the data memory and simultaneously output to the interface a measurement dataset:

1	Press the <STO> key. The <i>Store</i> display appears.
---	---

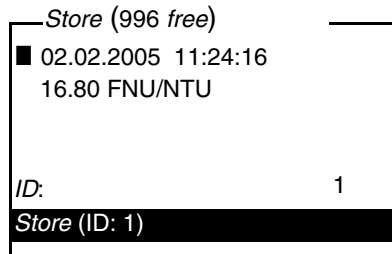

2	Using <▲> <▼>, <START/ENTER> and the number keys, change and confirm the ID number (<i>ID</i>) as necessary (0 ... 999).
---	--

3	Using <START/ENTER> or <STO>, confirm <i>Store</i> . The dataset is stored. The instrument switches to the measured value display.
---	---



Note

A measurement dataset is stored quickly by twice pressing <STO>. It is stored with the ID last set.

If the memory is full

You can erase the entire memory (see section 4.6.5), or overwrite the oldest dataset with the next storing procedure.
A security prompt appears before a dataset is overwritten.

4.6.2 Filtering measurement datasets

The functions to display and download stored measurement datasets (see section 4.4.1) refer to all stored measurement datasets that correspond to the specified filter criteria.

The settings are given in the menu, *Configuration / System / Measured value memory / Data filter*.

Move to the *Configuration* menu with the <MENU> key.

Data filter	Menu item	Setting/function	Description
	<i>Filter</i>		Filter criteria:
		<i>No filter</i>	Data filter switched off
		<i>ID</i>	Selection according to ID number
		<i>Date</i>	Selection according to period
		<i>ID + Date</i>	Selection according to period and ID number
	<i>ID</i>		Entry of filter criteria
	<i>Date</i>		These menu items are made visible by selecting the filter criteria in the <i>Filter</i> menu.

4.6.3 Displaying measurement datasets

You can read out stored datasets to the display. Only those datasets are displayed that correspond to the selected filter criteria (see section 4.6.2).

Start reading out the data to the display in the menu, *Configuration / System / Measured value memory / Display*.

Representation of a dataset

```
02.02.2005 11:24:16
ID: 1
   16.80 FNU/NTU

■ Scroll with ▲ ▼
```

Further datasets that correspond to the filter criteria are displayed with the <▲> <▼> keys.

Quitting the display

To quit the display of stored measurement datasets, you have the following options:

- Switch directly to the measured value display with <M> (short pressure).
- Leave the display and switch to the superordinate menu with <ESC> or <START/ENTER>.

4.6.4 Download the measurement datasets to the RS232 interface

You can download stored datasets to the RS232 interface. Only those datasets are downloaded that correspond to the selected filter criteria (see section 4.6.2).

The datasets are downloaded in the specified output format (see section 4.7.3).

The data download to the interface is started in the menu, *Configuration / System / Measured value memory / RS232 download*.

4.6.5 Erasing stored measurement datasets

You can erase the stored measurement datasets altogether if you do no longer need them.

Erasing all measurement datasets is done in the menu, *Configuration / System / Measured value memory / Delete*.

**Note**

Erasing individual datasets is not possible. If all memory locations are occupied, however, it is possible to overwrite the oldest dataset at a time. A security prompt appears before a dataset is overwritten.

4.7 Transmitting data (RS 232 interface)

Via the RS 232 interface, you can transmit data to a PC or an external printer.

The data can be transmitted to a PC, for example, with the aid of a so-called terminal program.

Generally, a terminal program serves to establish a connection to a device on a data interface and to communicate with the device via a console on the display. A terminal program usually offers the possibility to save the contents of the console in a text file or print it. If the terminal program is connected to the meter, it can receive data from the meter and display it on the console.

Terminal programs are available for different operating systems by different manufacturers. Windows (version 95 to XP) contains the "HyperTerminal" terminal program. It is in the program menu under *Accessories*.

For more detailed information please refer to the user information of the terminal program.

The settings required for the use of the "HyperTerminal" program are given in section 4.7.1.

**Note**

When using the "HyperTerminal" program you can load the transmission data automatically using the *.ht file provided on the CD.

4.7.1 Connecting a PC/external printer

Connect the interface to the devices via the AK540/B (PC) or AK540/S (external printer) cable.



Caution

The RS232 interface is not galvanically isolated. When connecting an earthed PC/printer, measurements cannot be performed in earthed media as incorrect values would result.

Set up the following transmission data on the PC/printer:

Baud rate	can be selected from: 1200, 2400, 4800, 9600, 19200 The baud rate must agree with the baud rate set on the PC/printer.
Handshake	RTS/CTS
PC only:	
Parity	none
Data bits	8
Stop bits	1s

Socket assignment

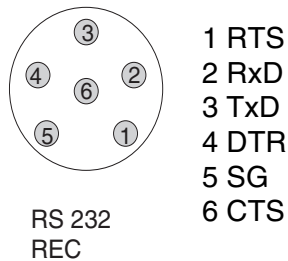

4.7.2 Configuring the RS232 interface

For error-free data transmission, the RS232 interface should be set to the same transmission speed (*Baud rate*) on the Turb 430 IR/T and PC/printer.

You can set the following values for the baud rate on the Turb 430 IR/T: 1200, 2400, 4800, 9600, 19200.

The baud rate is selected in the menu, *Configuration / System / Interface / Baud rate*.

4.7.3 Selecting the output format of datasets

For downloading data to the interface you can select the output format.

It is selected in the menu, *Configuration / System / Interface / Output format*.

The ASCII output format delivers formatted datasets.

The CSV output format delivers datasets separated by ";".

Output format, ASCII

```
Turb 430 IR Ser. no. 12345678
31.10.04 09:56:20
ID: 1
    16.01 FNU/NTU

-----

Turb 430 IR Ser. no. 12345678
31.10.04 15:48:08
ID: 1
    26.01 FNU/NTU

-----

etc...
```

Output format, CSV

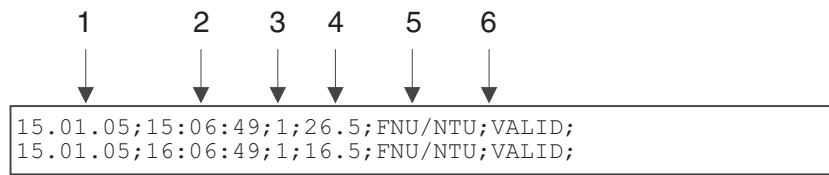

	Data	Description
1	Date	Date of storing
2	Time	Time of storing
3	ID	adjusted ID
4	Measured value	<ul style="list-style-type: none"> ● Measured value or ● Upper/lower measuring range limit (only with measured value status, OFL/UFL)
5	Unit of 4	<ul style="list-style-type: none"> ● Unit of the measured value
6	Measured value status of 4	<ul style="list-style-type: none"> ● VALID: Measured value valid ● INVALID: Measured value invalid ● UFL: Measured value below the lower measuring range limit ● OFL: Measured value above the upper measuring range limit

4.7.4 Transmitting data

The following table shows which data are transmitted to the interface in which way:

Data	Operation / description
Current measured value	<ul style="list-style-type: none">● Press <PRT>.● Simultaneously with every manual storage process.
Stored measured values	<ul style="list-style-type: none">● Display stored dataset and press <PRT>.● All datasets according to the filter criteria via the <i>RS232 download</i> function (see section 4.6.2).

**Note**

With the <PRT> key you output data that is being shown on the display to the interface (displayed measured values, stored measurement datasets, calibration record).

4.8 Reset

You can reset (initialize) all system and measurement settings.

4.8.1 Resetting the system settings

With the *System / Reset* function, all resettable settings are reset.

- Settings for *Turbidity* (see section 4.8.2)
- System settings

System setting	Default settings
<i>Baud rate</i>	4800 Baud
<i>Output format</i>	ASCII
<i>Illumination</i>	<i>Auto off</i>
<i>Contrast</i>	50 %
<i>Brightness</i>	50 %
<i>Switchoff time</i>	30 min
<i>Beep</i>	<i>On</i>

4.8.2 Resetting turbidimeter settings

With the *Turbidity / Reset* function, all turbidimeter settings are reset.

Setting	Default settings
<i>Calibration interval</i>	90 d

4.9 Meter information

The following meter information is listed in the *Configuration / Info* menu:

- Model designation
- Software version
- Series number of the meter

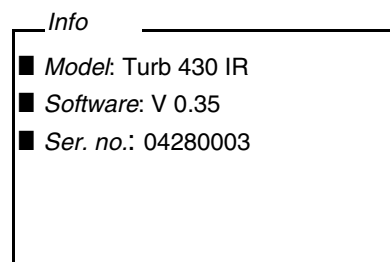

4.10 Software update

With a software update you obtain the current instrument software (see appendix).

The current software version can be found on the Internet under www.WTW.com.

The proceeding for updating the software is given in the appendix (see APPENDIX: FIRMWARE UPDATE).

5 Maintenance, cleaning, disposal

5.1 Maintenance

The meter is almost maintenance-free.
The only maintenance task is replacing the batteries or accumulator pack.

5.1.1 Inserting/exchanging the batteries



Caution

Make sure that the poles of the batteries are the right way round. The \pm signs on the batteries must correspond to the \pm signs in the battery compartment.

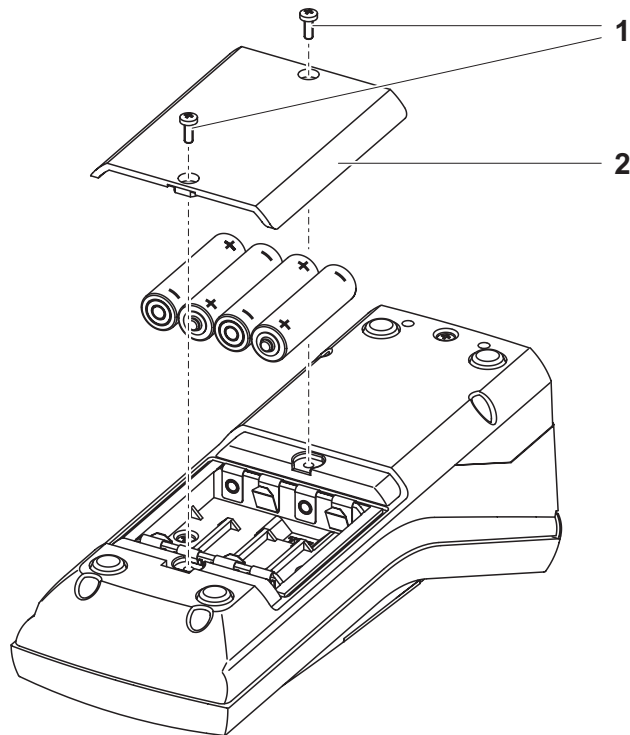

- | | |
|---|---|
| 1 | Open the battery compartment: <ul style="list-style-type: none"> – Unscrew the two screws (1) on the underside of the meter, – Remove the lid of the battery compartment (2). |
| 2 | If necessary, take four old batteries out of the battery compartment. |
| 3 | Insert four batteries (3) in the battery compartment. |
| 4 | Close the battery compartment and fix it with the screws. |

5.1.2 Retrofitting the accumulator pack



Caution

Use original WTW accumulator packs only.

Together with the power pack the accumulator pack is available as an accessory (see section 8.1).

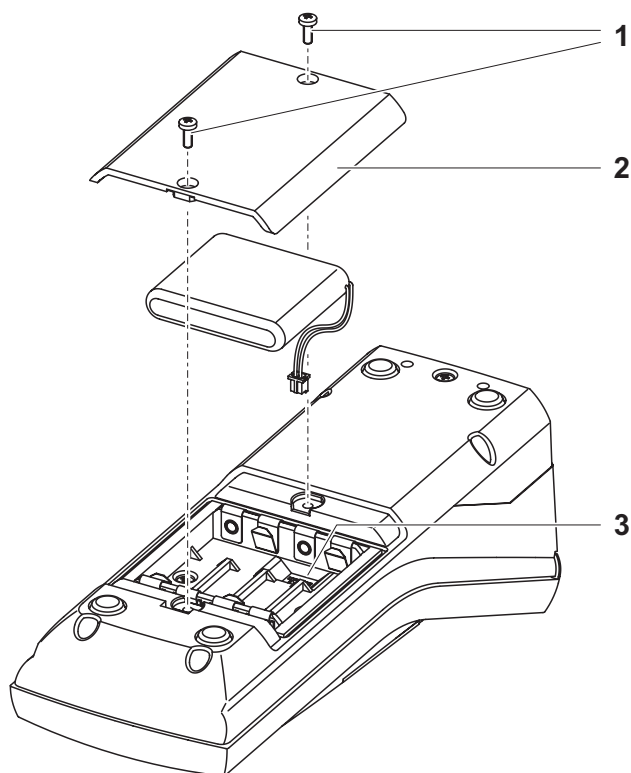

- | | |
|---|--|
| 1 | Open the battery compartment: <ul style="list-style-type: none">– Unscrew the two screws (1) on the underside of the meter,– Remove the lid of the battery compartment (2). |
| 2 | If necessary, take four old batteries out of the battery compartment. |
| 3 | Connect the cable of the accumulator pack with the socket (3) on the bottom of the battery compartment and insert the accumulator pack in the battery compartment. |
| 4 | Close the battery compartment and fix it with the screws. |

5.2 Cleaning

Occasionally wipe the outside of the meter with a damp, lint-free cloth. Disinfect the housing with isopropanol as required.



Caution

The housing components are made out of synthetic materials (polyurethane, ABS and PMMA). Thus, avoid contact with acetone and similar detergents that contain solvents. Remove any splashes immediately.

5.2.1 Cleaning the cell shaft

If liquid is in the cell shaft (e.g. due to a spilled cell), clean the cell shaft as follows:

1	Switch the Turb 430 IR/T off and pull out the power plug.
2	Rinse the cell shaft with distilled water.

5.2.2 Cleaning the cells

Cells have to be clean, dry, and free of fingerprints and scratches. Therefore, clean them regularly:

1	Clean the cells inside and out with hydrochloric acid or laboratory soap.
2	Rinse out several times with distilled water.
3	Let them dry in the air.
4	Only hold the cells by the top or by the light protection cap so that the optical path is not impaired.
5	Before measuring, clean the cell with the enclosed cleaning cloth.



Note

Scratches in the glass change the optical characteristics of the cell and falsify the measured value. For this reason, never use scratched cells!

5.3 Disposal

Packing

This meter is sent out in a protective transport packing. We recommend: Keep the packing material. The original packing protects the instrument against damage during transport.

Batteries/accumulator pack



NiMH

Remove the batteries or accumulator pack from the meter (see section 5.1). Dispose of the batteries or accumulator pack at a suitable facility according to local legal requirements. It is illegal to dispose of the accumulator pack with household refuse.

Meter

Dispose of the meter without the batteries and accumulator pack as electronic waste at an appropriate collection point.

6 What to do if...

6.1 General errors

Display, <i>LoBat</i>	Cause <ul style="list-style-type: none"> – The batteries or accumulator pack are largely depleted 	Remedy <ul style="list-style-type: none"> – Insert new batteries – Charge the accumulator pack (see section 3.2)
Instrument does not react to keystroke	Cause <ul style="list-style-type: none"> – Software error – Operating condition undefined or EMC load unallowed 	Remedy <ul style="list-style-type: none"> – Processor reset: Press the <START/ENTER> and <PRT> key simultaneously.
Error message, <i>Error 0, 8, 16, 16384</i>	Cause <ul style="list-style-type: none"> – Instrument error 	Remedy <ul style="list-style-type: none"> – Repeat measurement – Meter defective, send meter to WTW for repair and quote the error number

6.2 Turbidity

Error message, Measured values obviously incorrect	Cause <ul style="list-style-type: none"> – Cell not correctly inserted – Cell contaminated – Calibration too old 	Remedy <ul style="list-style-type: none"> – Lock cell into place – Clean the cell – Carry out calibration
Measured value display < 0.01 FNU	Cause <ul style="list-style-type: none"> – Calibration defective – Measured value outside the measuring range 	Remedy <ul style="list-style-type: none"> – Carry out calibration – not possible

7 Technical data

7.1 General data

7.1.1 Turb 430 IR/T

Dimensions	approx. 236 x 86 x 117 mm	
Weight	approx. 0.6 kg (without batteries)	
Mechanical structure	Type of protection	IP 67
Electrical safety	Protective class	III
Test certificates	cETLus, CE, FCC	
Ambient conditions	Storage	- 25 °C ... + 65 °C
	Operation	0 °C ... + 50 °C
	Climatic class	2
Allowable relative humidity	Yearly mean:	75 %
	30 days /year:	95 %
	other days:	85 %
Power supply	Batteries	4 x 1.5 V, type AA
	Operating time with battery operation	Turb 430 IR: approx. 3000 measurements Turb 430 T: approx. 2000 measurements
	Accumulator pack (optional)	5 x 1.2 V nickel metal hydride (NiMH), type AA
	Power pack Charging device (optional)	FRIWO FW7555M/09, 15.1432.500-00 Friwo Part. No. 1883259 Input: 100 ... 240 V ~ / 50 ... 60 Hz / 400 mA Output: 9 V = / 1.5 A Connection max. overvoltage category II Primary plugs contained in the scope of delivery: Euro, US, UK and Australian.
Serial interface	Connection of the cable AK 540/B or AK 540/S	
	Baud rate	adjustable: 1200, 2400, 4800, 9600, 19200 Baud
	Type	RS232
	Data bits	8
	Stop bits	2
	Parity	None
	Handshake	RTS/CTS
	Cable length	max. 15 m

Guidelines and norms used

EMC	EC guideline 89/336/EEC EN 61326-1/A3:2003 FCC Class A
Instrument safety	EC guideline 73/23/EEC EN 61010-1 :2001 UL STD 61010-1 CAN/CSA-C22.2 No. 61010-1
Climatic class	VDI/VDE 3540
IP protection	EN 60529:1991

FCC Class A Equipment Statement

Note: This equipment has been tested and found to comply with the limits for a Class A digital device, pursuant to Part 15 of the FCC Rules. These limits are designed to provide reasonable protection against harmful interference when the equipment is operated in a commercial environment. This equipment generates, uses, and can radiate radio frequency energy and, if not installed and used in accordance with the instruction manual, may cause harmful interference to radio communications. Operation of this equipment in a residential area is likely to cause harmful interference in which case the user will be required to correct the interference at his own expense.

7.1.2 LabStation

**Dimensions
Weight**

approx. 236 x 82 x 170 mm
approx. 0.6 kg

7.2 Turbidity

7.2.1 Turb 430 IR

Measuring principle	Nephelometric measurement according to DIN EN ISO 7027	
Light source	Infrared LED	
Measuring range	0.01 ... 1100 FNU/NTU	
Resolution	in the range 0,01 ... 9,99	max. 0.01 FNU/NTU
	in the range 10,0 ... 99,9	max. 0.1 FNU/NTU
	in the range 100 ... 1100	max. 1 FNU/NTU
Accuracy	in the range 0 ... 1100 FNU/NTU	$\pm 2\%$ of the measured value or ± 0.01 FNU/NTU
Reproducibility	0,5% of the measured value	
Response time	4 seconds	
Calibration	Automatic 3-point calibration	

7.2.2 Turb 430 T

Measuring principle	Nephelometric measurement according to US EPA 180.1	
Light source	White light tungsten lamp	
Measuring range	0.01 ... 1100 NTU	
Resolution	in the range 0,01 ... 9,99	max. 0.01 NTU
	in the range 10,0 ... 99,9	max. 0.1 NTU
	in the range 100 ... 1100	max. 1 NTU
Accuracy	in the range 0 ... 500 NTU	$\pm 2\%$ of the measured value or ± 0.01 NTU
	in the range 500 ... 1100 NTU	$\pm 3\%$ of the measured value
Reproducibility	1% of the measured value	
Response time	7 seconds	
Calibration	Automatic 3-point calibration	

8 Accessories, options

8.1 WTW accessories

Description	Model	Order no.
LabStation	pHotoFlex LS	251 301
Accumulator with Turb 430 IR/T power pack	pHotoFlex BB	251 300
3 empty cuvettes, 28 x 60 mm	LKS28-Set	251 302
Calibration standard kit for Turb 430 IR	Kal.Kit Turb 430 IR	600 560
Calibration standard kit for Turb 430 T	Kal.Kit Turb 430 T	600 561
Thermoprinter*	P3001	250 045
Needle printer*	LQ 300+	250 046

* a connection cable is required to connect the printer (see section 8.1.1)

8.1.1 Connection cable:

PC You can connect a PC (serial COM interface) to the Turb 430 IR/T as follows:

Description	Model	Order no.
● Connection PC - Turb 430 IR/T		
– Cable	AK 540/B	902 842
+ USB adapter (for USB connection on PC)	Ada USB	902 881
● Connection PC - LabStation		
– Zero modem cable	included in the scope of delivery of the LabStation	
+ USB adapter (for USB connection on PC)	Ada USB	902 881

Thermoprinter

You can connect the P3001 to the Turb 430 IR/T in the following ways:

Description	Model	Order no.
● Connection P3001 - Turb 430 IR/T		
– Cable	AK 540/S	902 843
● Connection P3001 - LabStation		
– Cable in conjunction with an adapter (socket - socket) [GenderChanger]	AK 3000 Specialist shops	250 745
or:		
– Cable, 2 x 9-pin (socket - plug)	Specialist shops	

Needle printer

You can connect an LQ300 needle printer to the Turb 430 IR/T in one of the following ways:

Description	Model	Order no.
● Connection LQ300 - Turb 430 IR/T		
– Cable with adapter 9-pin (plug) - 25-pin (plug)	AK 540/B Specialist shops	902 842
● Connection LQ300 - LabStation		
– Cable in conjunction with an adapter (socket - socket) [GenderChanger]	AK/LQ300 Specialist shops	250 746
or:		
– Zero modem cable, 9-pin (socket) - 25-pin (plug)	Specialist shops	

9 Lists

This chapter provides additional information and orientation aids.

Abbreviations

The list of abbreviations explains the indicators and the abbreviations that appear on the display and in the manual.

Specialist terms

The glossary briefly explains the meaning of the specialist terms. However, terms that should already be familiar to the target group are not described here.

Abbreviations

Cal	Calibration
d	Day
h	Hour
j	Year
LoBat	Batteries almost empty (Low battery)
m	Month
s	Second
S	Slope (internat. k)
SELV	Safety Extra Low Voltage
<i>Sp.</i>	Slope determined with calibration

Glossary

Adjusting	To manipulate a measuring system so that the relevant value (e. g. the displayed value) differs as little as possible from the correct value or a value that is regarded as correct, or that the difference remains within the tolerance.
Calibration	Comparing the value from a measuring system (e. g. the displayed value) to the correct value or a value that is regarded as correct. Often, this expression is also used when the measuring system is adjusted at the same time (see adjusting).
Cell	Vessel that takes a liquid sample for measurement.
LED	Light Emitting Diode LEDs are used as the light source in the Turb 430 IR/T.
Measured parameter	The measured parameter is the physical dimension determined by measuring, e. g. pH, conductivity or DO concentration.
Measured value	The measured value is the special value of a measured parameter to be determined. It is given as a combination of the numerical value and unit (e. g. 3 m; 0.5 s; 5.2 A; 373.15 K).
Measuring system	The measuring system comprises all the devices used for measuring, e. g. meter and sensor. In addition, there is the cable and possibly an amplifier, terminal strip and armature.
Molality	Molality is the quantity (in Mol) of a dissolved substance in 1000 g solvent.
Reset	Restoring the original condition of all settings of a measuring system.
Resolution	Smallest difference between two measured values that can be displayed by a meter.
Standard solution	The standard solution is a solution where the measured value is known by definition. It is used to calibrate a measuring system.
Test sample	Designation of the test sample ready to be measured. Normally, a test sample is made by processing the original sample. The test sample and original sample are identical if the test sample was not processed.

10 Index

A

Accumulator pack	
Charging time	13
Air	33
Aligning and marking a cell	33
Authorized use	10
Automatic switchoff function	14, 19

C

Calibration	36
Calibration order	36
Calibration points and measuring ranges ...	36
Calibration standards	36
Cleaning	53
Connecting a PC	44
Connecting a printer	44
Connecting sensors	7

D

Data filter	41
Dataset	40
Date and time	25, 32
Default settings	
System settings	48
Turbidimeter	48
Display	7, 31
Display illumination	7, 20

F

Filter	41
Firmware update	69

I

Initial commissioning	17
Initialization	48
Inserting a cell	20
Interface	31

J

Jack field	7
------------------	---

K

Keys	6
------------	---

M

Measured value display	21
Measured value memory	40
Measurement dataset	40
Measuring range overflow	35
Measuring turbidity	34
Menus (navigation)	21
Messages	22

N

Navigation	21
------------------	----

O

Obligations of the purchaser	11
Operating modes	21
Operational safety	10

P

Power pack	13
Print	47

R

Reset	48
RS232 socket assignment	44

S

Safe operation	11
Safety	9
Saving	40
Scope of delivery	13
Storage	29
Switching on	19
System settings	28

T

Target group	9
Transmitting data	43
Transmitting measured values	43
Turbidity	33

Appendix: Firmware update

General information

With the "Firmware Update Turb430" program you can update the firmware of the Turb 430 IR/T to the latest version with the aid of a Personal Computer.

A free serial interface (COM port) on your PC and an interface cable is required for this (see chapter 8 ACCESSORIES, OPTIONS).

Program installation

Install the firmware update program on your PC with the "Turb430_Vx_yy_English.exe" installation program.

Program start

Start the "Firmware Update Turb430" program from the WTW directory in the Windows start menu. The program automatically selects the first free serial interface (COM port). The selected interface is displayed on the left side of the status line on the screen bottom.

Via the language menu you can change the adjusted language.

Firmware update

Proceed as follows:

1	With the aid of an interface cable, connect the Turb 430 IR/T to the serial interface (COM port) of the PC named in the status line.
2	Make sure the Turb 430 IR/T is switched on.
3	To start the updating process click the OK button.
4	Then follow the instructions of the program. A corresponding message and a progress bar (in %) appear during the programming procedure. The programming procedure takes approx. four minutes. A final message appears after the successful programming procedure. The firmware update is completed with this.
5	Disconnect the meter from the PC. The instrument is ready for operation.

After switching the meter off and on again you can check on the start display whether the meter has taken over the new software version.

Appendix: Turbidity values under 1 FNU/NTU

With turbidity values (under 1 FNU/NTU), the measured value is strongly influenced by the cell and its alignment.

In order to increase measuring accuracy with turbidity values under 1 FNU/NTU, calibration in the 0.02 FNU/NTU standard and later measurement should be carried out in the same cell. For calibration in the standards 10.0 and 1000 FNU/NTU follow the instructions on the display.

Proceed as follows to measure turbidity values under 1 FU/NTU:

Calibration procedure:

1	Press the <CAL/ZERO> key. The menu-guided calibration begins.
2	Carry out calibration of the standards 1000 FNU/NTU and 10.0 FNU/NTU in a clean and unscratched cell according to the menu guidance.
3	Fill the cleaned cell with the 0.02 FNU/NTU standard and calibrate.
4	Mark the alignment of the cell.

Calibrate

- after the calibration interval has expired
- with a temperature change

Measuring

5	Fill the marked and cleaned cell with test sample, align it with the marking and measure.
6	If necessary, fill the marked and cleaned cell once more with test sample and carry out further measurements.



Wissenschaftlich-Technische Werkstätten GmbH

Dr.-Karl-Slevogt-Straße 1
D-82362 Weilheim

Germany

Tel: +49 (0) 881 183-0
+49 (0) 881 183-100
Fax: +49 (0) 881 183-420
E-Mail: Info@WTW.com
Internet: <http://www.WTW.com>